

STEREO POWER AMPLIFIER

# M-25

OPERATING INSTRUCTIONS

KU

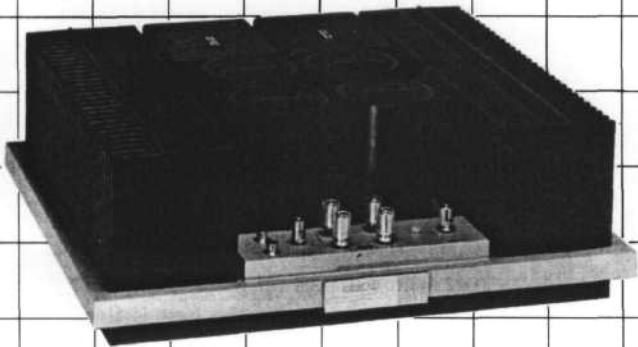

## CONTENTS

Features.....	2
Configuration of the Stereo System .....	3
Connection Diagram .....	4
Operation .....	5
Protective Circuitry .....	5
Combinations with the M-25 .....	6
Maintenance .....	6
Characteristics Charts .....	7
Specifications .....	8

### IMPORTANT NOTICE

The serial number for this equipment is located on the bottom plate. Please write this serial number on your enclosed warranty card and keep in a secure area. This is for your security.

**WARNING: TO PREVENT FIRE OR SHOCK HAZARD, DO NOT EXPOSE THIS APPLIANCE TO RAIN OR MOISTURE.**

**series20**<sup>®</sup>

---

## FEATURES

### **120W + 120W Power Amplifier with a Wide Frequency Band and Low Distortion**

The first stage of the M-25 adopts a dual transistor differential amplifier with a current mirror as the load for a superb stability and gain right from the lowest low frequencies to the highest high frequencies. The pre-driver stage consists of a voltage amplifier with a constant current circuit as the load, and this makes for a significant improvement in the degree of use of the power voltage, and also for a satisfying gain and linearity. The power stage features a Class-AB pure complementary parallel push-pull circuit with a three-stage Darlington connection. A newly developed power transistor called a "Ring Emitter Transistor" (RET) has been introduced into the new Class-AB circuitry. This feature guarantees an ultra wide frequency range which turns the attributes of the RET to maximum advantage, and also a superior low-distortion response whatever the power rating — across an ultra-low to full power spectrum. The M-25 delivers

**Continuous Power Output of 120 watts\* per channel, min., at 8 ohms from 5 Hertz to 30,000 Hertz with no more than 0.01% total harmonic distortion.**

In particular, the Class-AB SEPP circuit functions as a Class-A circuit which is highly rated on account of its hi-fidelity sound reproduction capabilities with low power outputs (up to 3W/8-ohms). This means that you can enjoy the final sound as you would from a Class-A amplifier. Finally, the pre-driver section contains an over-drive limiter and a power limiter for protecting the power transistors. This helps to greatly improve the reliability.

### **Twin Transformer Power Supply for Excellent Separation**

The M-25 is symmetrically designed with completely separate heavyweight class power supplies for each channel. Each employs large-capacity capacitors (two 22,000uF for each channel) which not only feature excellent regulation but also have plenty of reserve. Along with the wide-band frequency response, they ensure a superior channel separation and a reproduction of sound which is both clear and full of latent energy. There is also a surge-killer circuit to keep the inrush current from the power transformers as well as the high current which charges the electrolytic capacitors to the bare minimum, and this feature reduces the load on all of the related parts.

### **Highly Dependable Protective Circuitry**

The M-25 employs a relay type of protective circuit which is equipped with a current detector and an overcurrent detector. This circuit is designed to protect the speakers from unforeseen accidents caused by the generation of current in the output, or from shortcircuiting of the speaker terminals owing to faulty contacts, as well as the power transistors by releasing the output circuitry momentarily. Moreover, the output circuit relay is for 4-circuit high current uses and all the circuits are connected in parallel for enhanced reliability. This circuitry can also be counted on to perform muting when the power switch is flipped between ON and OFF.

### **Carefully Selected, High-quality Parts**

Each and every part which makes up the M-25 has been singled out for its quality so that only the best is finally chosen. Among the parts employed are gold-plated input and speaker terminals, printed circuit boards of paper epoxy resin with a high insulation resistance, and printed circuit boards using 70u thick copper foil, low-resistance pure copper plates for parallel connections and for the grounding wire, and non-inductive cement resistors.

### **Esthetically Satisfying and Full-bodied Design**

The visual appeal of the power transistors and heat sinks mounted on a broad-based silver-toned aluminum die-cast chassis is what you would expect from a top-quality power amplifier. Just one look at the M-25 is enough to convince you of its tremendous power and stability.

*\*Measured pursuant to Federal Trade Commission's Trade Regulation Rule on Power Output Claims for Amplifiers.*

# CONFIGURATION OF THE STEREO SYSTEM

The M-25 is a stereo power amplifier which displays a wide frequency response and a high output. So that full rein can be given to its performance, choose a preamplifier and a speaker system whose quality is on a par with that of the M-25.

**NOTE:**

The rated input of the M-25 is 1V. You will not be able to obtain the rated output if the output voltage of the preamplifier is less than 1V (rated output: 120W, 8-ohm load).

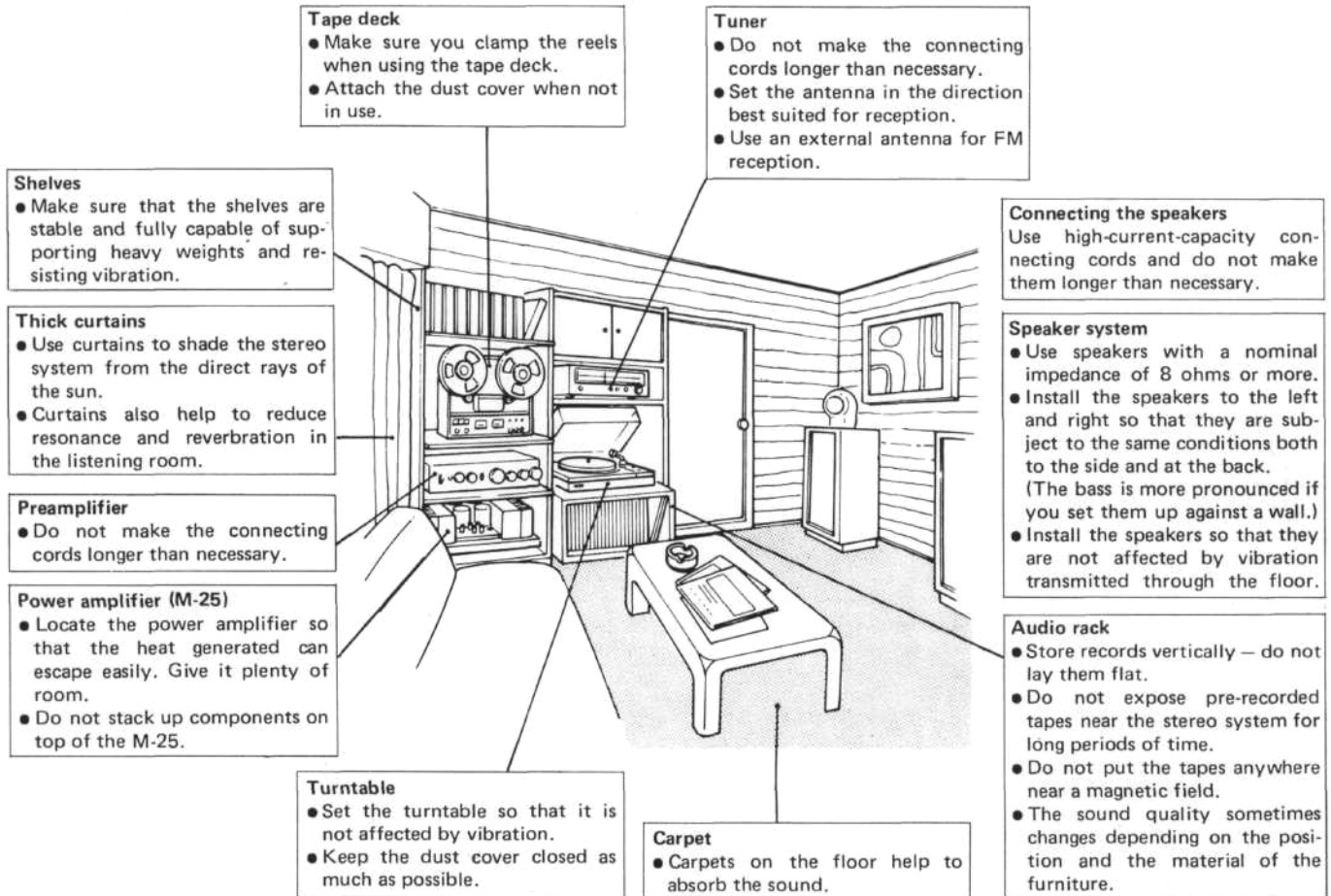

Do not install your M-25 in the locations listed in the table below.

Locations to be avoided	Possible trouble
1. Locations exposed to direct rays of the sun, or close to heating appliances or any heat-generating products.	1. External heat downgrades the performance of the electronic parts and prohibits stable operation.
2. Locations close to sources of alcohol, insecticides and other inflammables.	2. These items corrode the outer panel. There is also the danger that these items may ignite.
3. Locations with a high moisture or humidity level.	3. These locations cause a deterioration in the input/output connection contacts as well as internal corrosion. In particular, moisture and humidity downgrade the insulation and there is a danger of current leakage and heat generation in the circuit parts.
4. Locations with a great deal of dust or dirt.	4. Accumulated dust and dirt help prevent the heat from escaping. Furthermore, if combined with moisture or humidity, this can cause defects in the insulation.
5. Locations susceptible to vibration, or inclined and therefore unstable.	5. The M-25 is a heavy component and so any instability caused by an earthquake or the like can be dangerous and adversely affect the precision parts.

# CONNECTION DIAGRAM

Check that the power is off before you proceed with the connections. Always remember to switch the power off if you decide to change the connections while you are using the model.

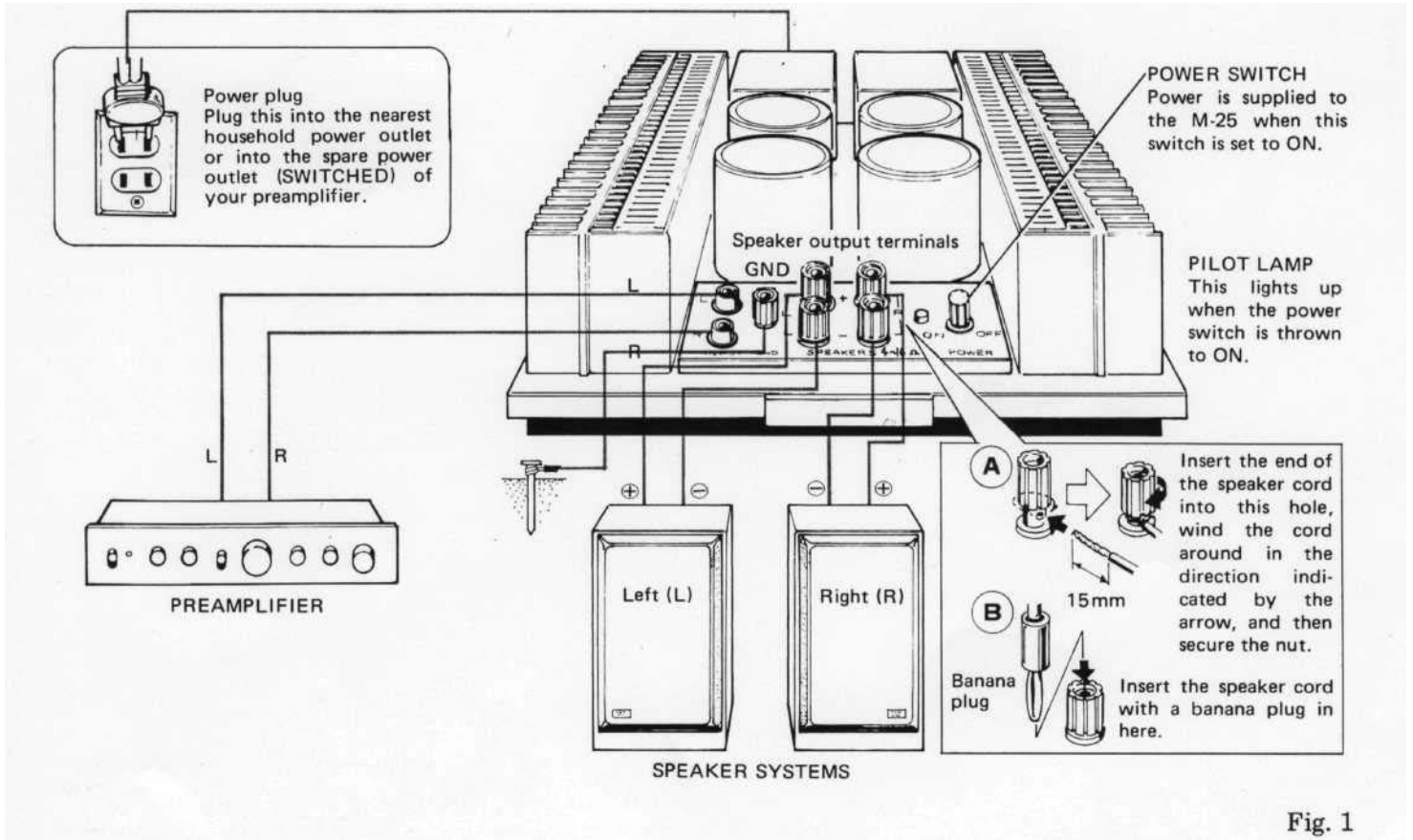

Fig. 1

## SPEAKER SYSTEM

As shown in Fig. 1, connect the R (right) channel speaker to the M-25's R speaker output terminals, and the L (left) channel speaker to the M-25's L speaker output terminals. Both speakers are clearly marked with plus and minus polarities (red and white, respectively). The M-25's speaker output terminals are similarly marked. Make sure that you connect like poles (plus to plus, minus to minus).

## PREAMPLIFIER

As shown in Fig. 2, use the accessory connecting cords to connect the stereo preamplifier's output terminals to the M-25's input terminals. The terminal which is closer to you is for the R (right) channel, and the connector furthest away is for the L (left) channel.

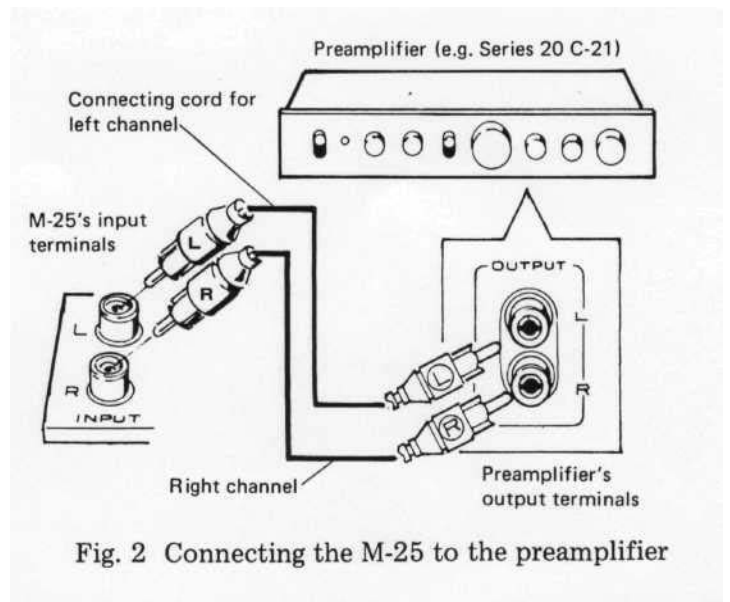

Fig. 2 Connecting the M-25 to the preamplifier

---

## OPERATION

### 1. Set the preamplifier's controls as follows:

- Set the preamplifier's power switch to OFF.
- Set the volume control (attenuator) to the lowest position.
- If your preamplifier has a tape monitor switch, set it to SOURCE (or OFF). Only when playing back a tape should it be set to ON.

### 2. Set the M-25 up as follows:

- Connect the power plug to the power outlet.  
If you have connected the power plug to the spare power outlet (SWITCHED: capacity of 800W or more) on the preamplifier, you will be able to switch the preamplifier on and off by operating the power switch on the M-25.

### 3. Beginning operation

- Set the power switches on the preamplifier and M-25 to ON.
- Operate the preamplifier, turntable, tape deck or tuner, and commence play.
- Adjust the volume and tone with the controls on the preamplifier.

## PROTECTIVE CIRCUITRY

- There will be no sound from the speakers for between three and eight seconds after the M-25's power switch has been thrown. This is because the supply of power actuates the muting circuit which is designed to eliminate noise when this switch is thrown. In addition, the protective circuitry is actuated to safeguard the speakers from being damaged in the rare case that DC components enter the output.
- If the sound suddenly stops coming from the speakers during operation or if you hear the built-in relays being continuously actuated ('click, click'), this may mean that there is a speaker connection short-circuit or an overload (if you are using speakers with an impedance of less than 4 ohms). In such cases, the protective circuitry is automatically actuated, and the transistors and speakers are protected from any damage. Once the trouble is corrected, the protective circuitry will be automatically released, and the M-25 will return to its normal state of operation.

# COMBINATIONS WITH THE M-25

## MULTIPLE AMPLIFIER SYSTEM

Fig. 3 shows a configuration based on two stereo power amplifiers which are used to drive a pre-amplifier, crossover network and four special speaker systems, all of which are separate buys. The main advantage of the multiple amplifier system is that it reduces the intermodulation distortion. It does this by dividing the audible frequency range and amplifying each of the separate frequencies with special stereo amplifiers. The audible frequency range can be split into two or three, in which case the resulting systems are known as 2-way or 3-way multiple amplifier systems.

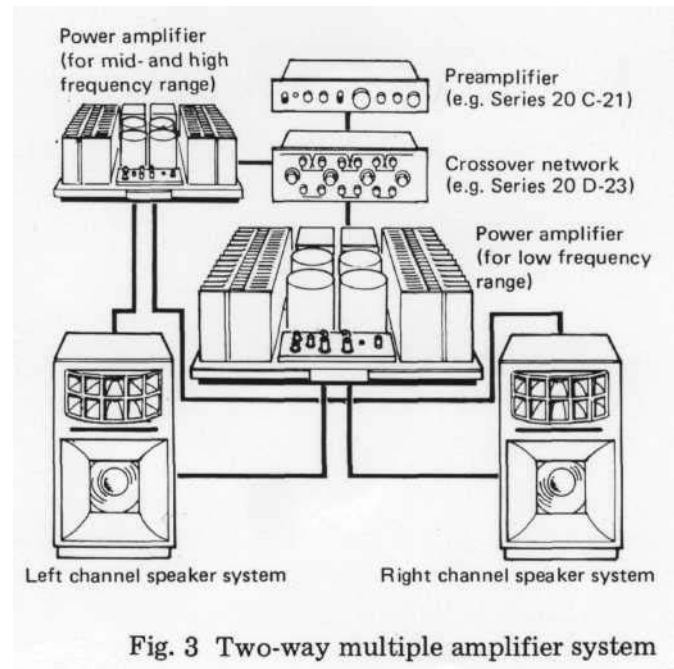

## MAINTENANCE

Wipe off any dirt or dust that accumulates on the operating panel or casing with a polishing cloth or dry, soft cloth. Clear out any dust between the fins of the radiator with a brush or similar object. Do not use furniture wax or cleaners. Remember also to avoid using thinners, benzene, alcohol and any other volatile chemicals since they will corrode the panels.

### ATTACHING THE NAME PLATE

The M-25's name plate is designed so that it can be attached to face you, whichever direction the M-25 is pointing. All you have to do is to turn the M-25 upside down, and remove the screw fastening the name plate with a Phillips screwdriver. Then, attach the plate to that side which you want to face you. Always remember that the M-25 is a heavy piece of equipment and so it should be handled with the greatest of care. Spread something under it when turning it upside down to prevent it from being marked.

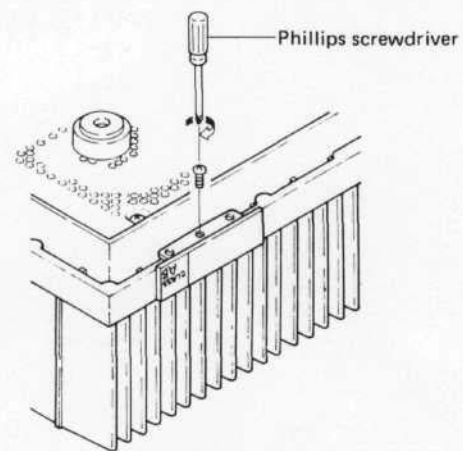

# CHARACTERISTICS CHARTS

## POWER BAND WIDTH

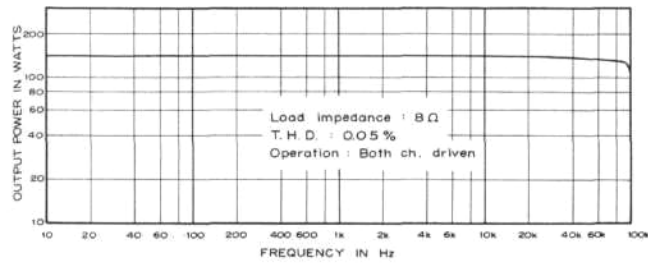

## SEPARATION

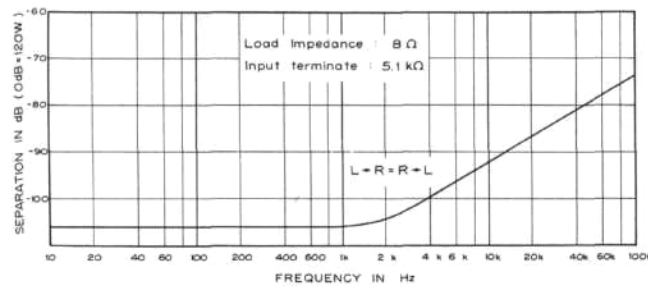

## FREQUENCY & PHASE

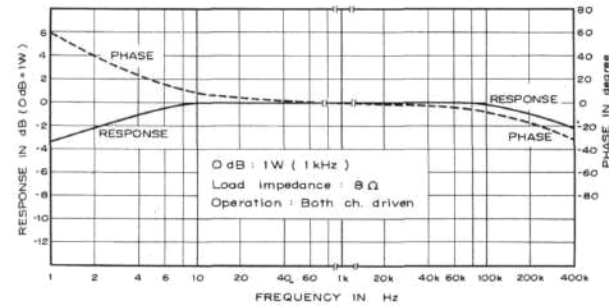

## OUTPUT POWER vs. TOTAL HARMONIC DISTORTION

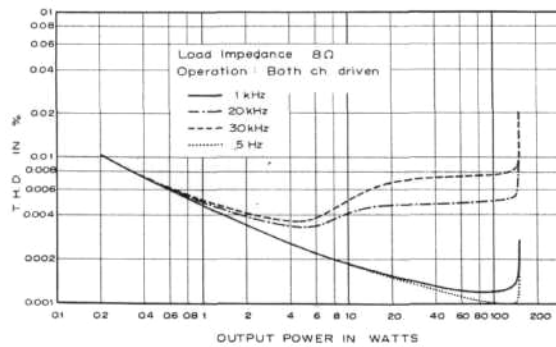

# SPECIFICATIONS

## Semiconductors

Transistors .....	55
Diodes.....	51

## Amplifier Section

Circuitry . . . First stage current mirror loaded, Three-stage Darlington, Parallel push-pull, Pure complementary OCL (class AB operation)

**Continuous Power Output of 120 watts\* per channel, min., at 8 ohms from 5 Hertz to 30,000 Hertz with no more than 0.01 % total harmonic distortion, or 120 watts per channel at 4 ohms from 5 Hertz to 20,000 Hertz with no more than 0.02% total harmonic distortion.**

Total Harmonic Distortion (20 Hertz to 20,000 Hertz, 8 ohms)

Continuous rated power output. .No more than 0.0 08%

Total Harmonic Distortion (5 Hertz to 30,000 Hertz, 8 ohms)

Continuous rated power output. . No more than 0.01%  
60 watts per channel

power output. .... No more than 0.008%

1 watt per channel

power output.....No more than 0.008%

Intermodulation Distortion (50 Hertz : 7,000 Hertz=4:1)

Continuous rated power output . . No more than 0.006%

60 watts per channel

power output.....No more than 0.005%

1 watt per channel

power output.....No more than 0.005%

Frequency Response . . 5 Hertz to 200,000 Hertz <sup>+0</sup>/<sub>-1</sub>dB

Input (Sensitivity / Impedance)..... 1V/50 kilohms

Output

Speaker.....4 ohms to 16 ohms

Damping Factor (5 Hertz to 30,000 Hertz, 8 ohms). . . .60

Hum and Noise (IHF, short-circuited, A network) . . 120dB

## Miscellaneous

Power Requirements .....	120V, 60Hz only
Power Consumption .....	320 watts (UL)
Dimensions.....	420(W) x 153(H) x 370(D)mm 16-9/16 x 6 - 1/32 x 14-9/16 in.
Weight without package .....	23.5kg; 51 lb 11 oz
with package .....	26.2kg; 57 lb 10oz

## Furnished Parts

Connection Cord with Pin Plugs .....	1
Operating Instructions .....	1

*\*Measured pursuant to Federal Trade Commission's Trade Regulation rule on Power Output Claims for Amplifiers.*

### NOTE:

*Specifications and the design subject to possible modification without notice due to improvements.*

**series20<sup>®</sup>**

20 Jewell Street

Moonachie, New Jersey 07074



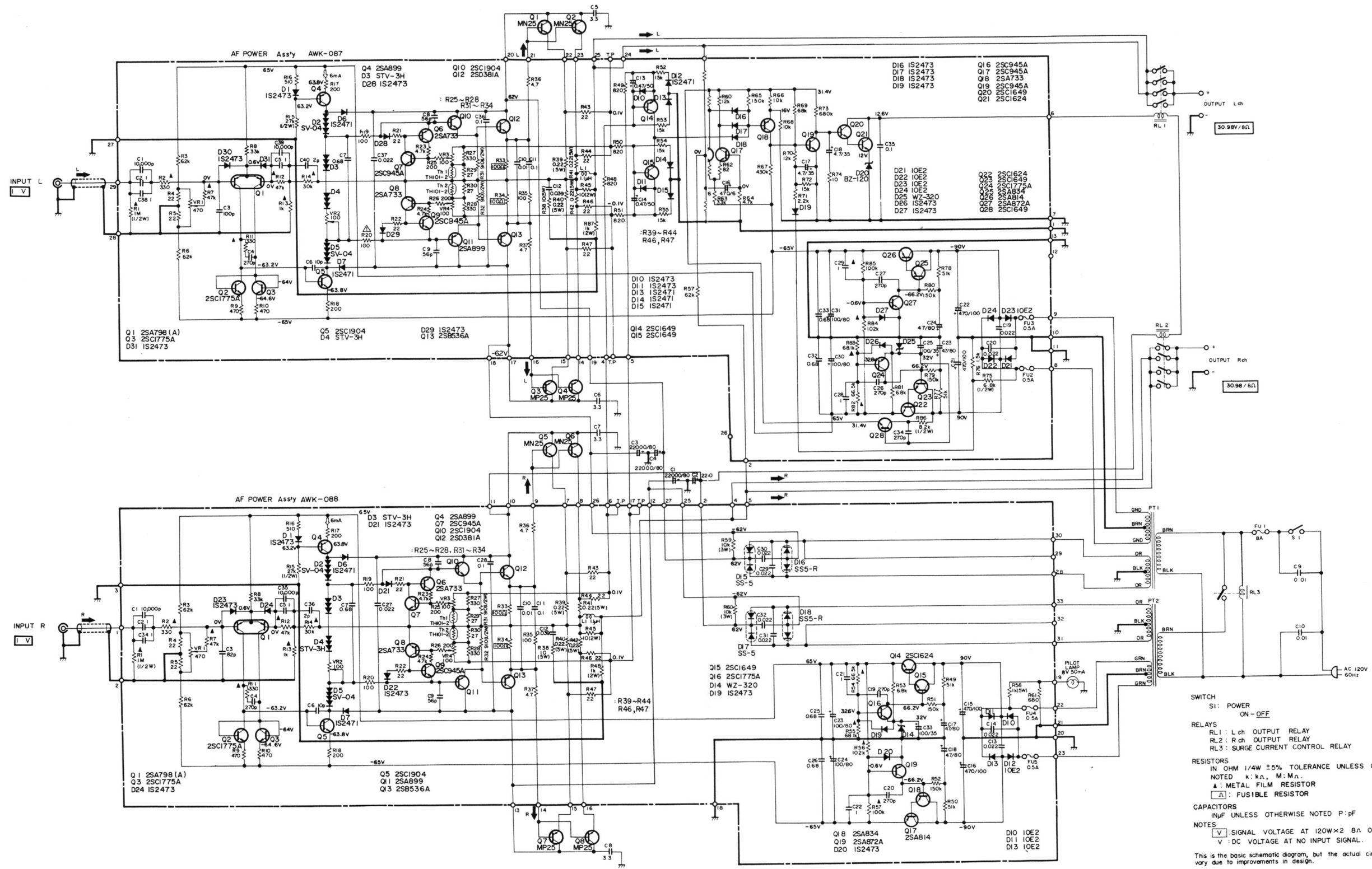

SWITCH  
S1: POWER ON - OFF

RELAYS  
RL1: L ch OUTPUT RELAY  
RL2: R ch OUTPUT RELAY  
RL3: SURGE CURRENT CONTROL RELAY

RESISTORS  
IN OHM 1/4W ±5% TOLERANCE UNLESS OTHERWISE NOTED  
NOTED k: k.Ω, M: M.Ω  
⊓: METAL FILM RESISTOR  
⊓: FUSIBLE RESISTOR

CAPACITORS  
IN μF UNLESS OTHERWISE NOTED P: pF

NOTES  
[V] SIGNAL VOLTAGE AT I20W X 2 8Ω OUTPUT  
[V] DC VOLTAGE AT NO INPUT SIGNAL.

This is the basic schematic diagram, but the actual circuit may vary due to improvements in design.

# M-25 Specifications

Circuitry: First stage Current mirror loaded, 3-stage Darlington parallel Push-pull pure complementary OCL (class AB operation)

**Continuous power output of 120 watts\* per channel, min. at 8 ohms from 5 hertz to 30,000 hertz with no more than 0.01% total harmonic distortion, or 120 watts\* per channel at 4 ohms from 5 hertz to 20,000 hertz with no more than 0.02% total harmonic distortion.**

Total Harmonic Distortion: No more than 0.008%  
(20Hz to 20,000Hz, 8 ohms) (continuous rated power output)

Total Harmonic Distortion: No more than 0.01%  
(5Hz to 30,000Hz, 8 ohms) (continuous rated power output)

No more than 0.008%  
(60 watts per channel power output)

No more than 0.008%  
(1 watt per channel power output)

Intermodulation Distortion: No more than 0.006%  
(50Hz:7,000Hz=4:1) (continuous rated power output)  
No more than 0.005%  
(60 watts per channel power output)  
No more than 0.005%  
(1 watt per channel power output)

Frequency Response: 5 to 20,000Hz +0dB, -1 .0dB  
Input Sensitivity/Impedance: 1V/50k ohms  
Output  
Speaker: 4 ohms to 16 ohms  
Damping Factor: 60 (5 to 30,000Hz, 8 ohms)  
Hum and Noise: 120dB  
(IHF, short-circuited A network)

## SEMICONDUCTORS

Transistors: 55  
Diodes: 51

## MISCELLANEOUS

Power Requirement: 120V 60Hz only  
Power Consumption: 320 watts (UL)  
Dimensions: Without package: '  
16-9/16(W)x 6-1/16(H)x  
14-9/16(D) inches  
420(W) x 153(H) x 370(D)mm  
Weight: Without package:  
51 lb. 13oz./23.5kg

Measured pursuant to the Federal Trade Commission's Trade Regulation Rule on Power Output Claims for Amplifiers.  
NOTE: Specifications and design subject to possible modification without notice, at the sole discretion of Series 20.

The logo for Series 20 features the word "series" in a lowercase, sans-serif font, followed by the number "20" in a large, bold, stylized font with a registered trademark symbol. The "20" has a thick, blocky appearance with a slight shadow effect.

20 Jewell Street  
Moonachie, New Jersey 07074  
(201) 440-1220